

430ml / 12oz Kraft BioBowl BSCK-12-GS

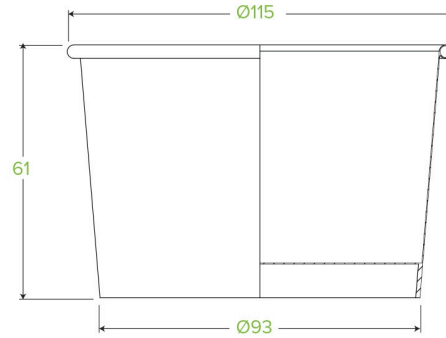

12oz kraft paper bowls are lined with a plant-based bioplastic, not fossil-fuel plastic. Certified industrially compostable. Suitable for hot/cold food and soup-safe. This compostable bowl is printed kraft-look.

Carton quantity: 500	Sleeves per carton: 20	Units per sleeve: 25
Carton Size LxWxH (cm): 58x46.5x29	Carton gross weight (kg): 7.000000	Carton barcode: 19344062023392
Raw material: Paper	Lining/coating: Bioplastic - Ingeo™ PLA	Window material: None
Printing Type: Offset	Inks: Food Contact Safe Inks	Brim fill capacity (ml): 420
Dimensions top LxW (mm): 115	Dimensions base LxW (mm): 92	Product Depth: 62
Product weight (g): 11.71	Thickness: 320gsm	Use: Hot and cold
Manufactured: Taiwan	Customise: None	MOQ custom: 25000
Mould fees: No	Environmental production certified: ISO 14001	Quality product certified: ISO 9001
Factory food safety certified: BRC	Corporate social accreditation: SMETA	Home compostable: No
Industrially compostable: Certified to AS4736 Australian Standards, Certified to EN13432 European Standard	Recyclable: No	