

360ml Clear BioCup R-360Y

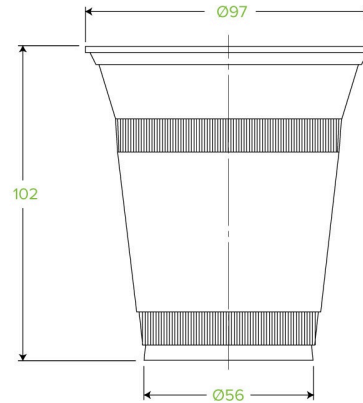

360ml BioCups look and perform like conventional plastic cups but are made from bioplastic. Certified industrially compostable. Cold use only.

Carton quantity: 1000	Sleeves per carton: 20	Units per sleeve: 50
Carton Size LxWxH (cm): 50x40x38	Carton gross weight (kg): 10.300000	Carton barcode: 19344062000652
Raw material: Bioplastic - PLA	Lining/coating: None	Window material: None
Printing Type: Offset	Inks: Food Contact Safe Inks	Brim fill capacity (ml): 375
Dimensions top LxW (mm): 96x96	Dimensions base LxW (mm): 56x56	Product Depth: 84
Product weight (g): 9.321	Use: Cold use only	Manufactured: Taiwan
Customise: Print	MOQ custom: 50000	Mould fees: Yes - see custom packaging
Environmental production certified: ISO 14001	Quality product certified: ISO 9001	Factory food safety certified: FSSC 22000
Corporate social accreditation: NONE AVAILABLE	Home compostable: No	Industrially compostable: Certified to AS4736 Australian Standards, Certified to EN13432 European Standard
Recyclable: No		