

1,200ml Kraft BioBoard Square Takeaway Base BB-SLB-1200-N

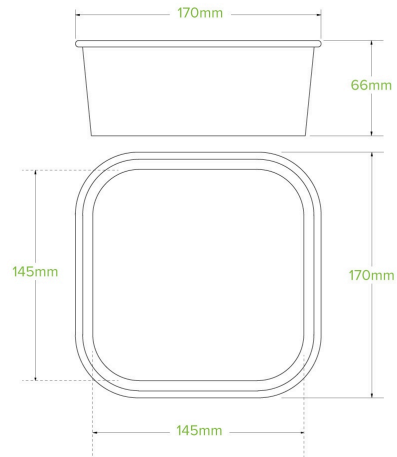

Our kraft 1,200ml square paper containers are sustainably sourced, made from FSC™ certified paper board. They are lined with a bioplastic made from plants, not oil. These takeaway containers are perfect for displaying meals. Certified industrially compostable.

Carton quantity: 300	Sleeves per carton: 6	Units per sleeve: 50
Carton Size LxWxH (cm): 52x35x59	Carton gross weight (kg): 8.000000	Raw Material: Paper - FSC™ Mix certified paper
Lining/coating: PLA	Window Material: None	Inks: Food Contact Safe Inks
Brim fill capacity (ml): 1280	Dimensions top LxW (mm): 170x170	Dimensions base LxW (mm): 148x148
Product Depth: 66	Product weight (g): 24.3	Thickness: 320gsm+30g
Use: Hot, Cold, Wet & Dry Products	Customise: Print	MOQ custom: 30000
Mould fees: No	Environmental production certified: ISO 14001	Quality product certified: ISO 9001
Factory food safety certified: BRC	Corporate social accreditation: NONE AVAILABLE	Home compostable: No
Industrially compostable: Certified to AS4736 Australian Standards, Certified to EN13432 European Standards	Recyclable: No	