

#16 SOS Kraft Paper Bag BAG-SOS-16-B

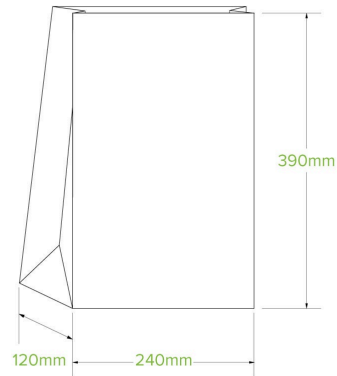

Our kraft SOS bags are made from high-quality and sustainably sourced FSC™ certified paper with no handles. These SOS paper bags are versatile, making them a top choice for packing breads, bakery delights and takeout meals on the go. They are recyclable, reusable and suitable for composting. This SOS bag has 5kg weight capacity. Available in seven sizes and in white.

Carton quantity: 250	Sleeves per carton: 1	Units per sleeve: 250
Carton Size LxWxH (cm): 41x26x22	Carton gross weight (kg): 7.000000	Raw Material: Paper - FSC™ Mix certified paper
Lining/coating: None	Window Material: None	Printing Type: Flexo
Inks: Food Contact Safe Inks	Brim fill capacity (ml): 11232	Dimensions top LxW (mm): 240x120
Dimensions base LxW (mm): 240x120	Product Depth: 390	Product weight (g): 25.45
Thickness: 70gsm	Use: Hot, Cold & Dry Products	Manufactured: China
Customise: Print	MOQ custom: 10000	Mould fees: No
Environmental production certified: ISO 14001	Quality product certified: ISO 9001	Factory food safety certified: BRC
Corporate social accreditation: SMETA	Home compostable: Suitable for composting	Industrially compostable: Suitable for composting
Recyclable: No		